

**SS56**  
TECHNICAL DATA

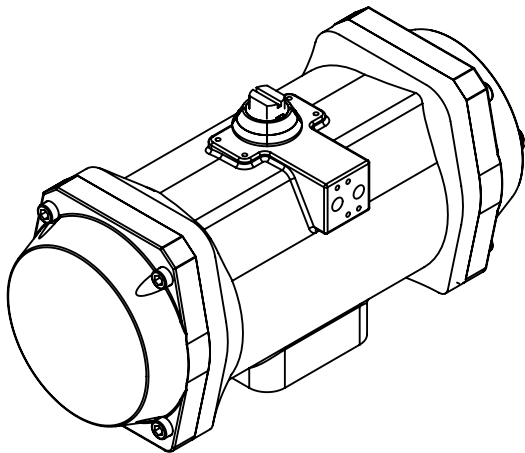

DIMENSIONS TO  
ISO 5211 - DIN 3337  
AND NAMUR VDI/VDE 3845

DIMENSIONS IN INCHES

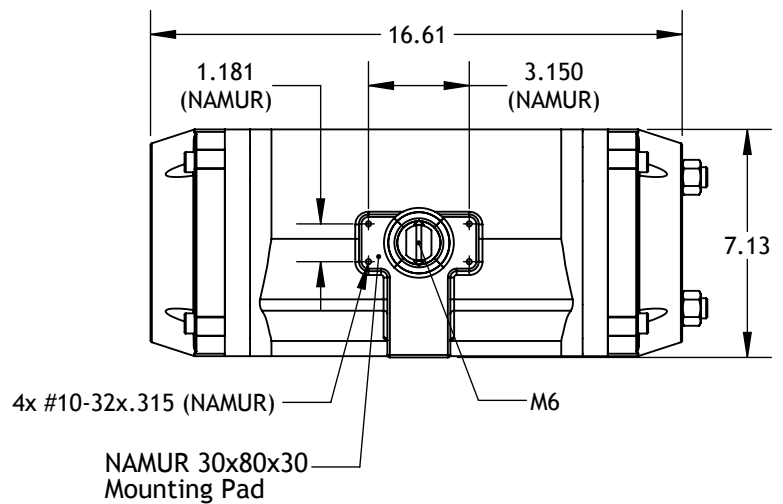
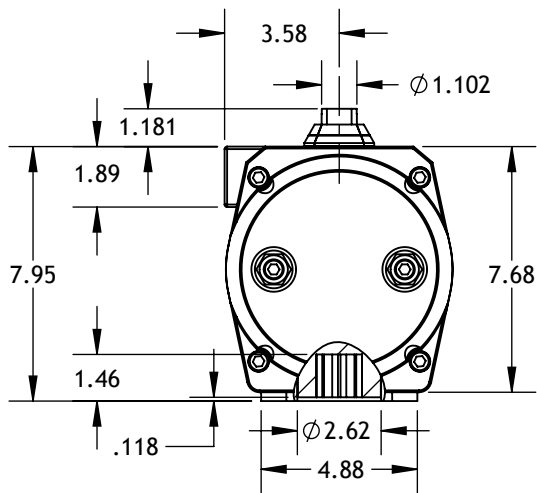
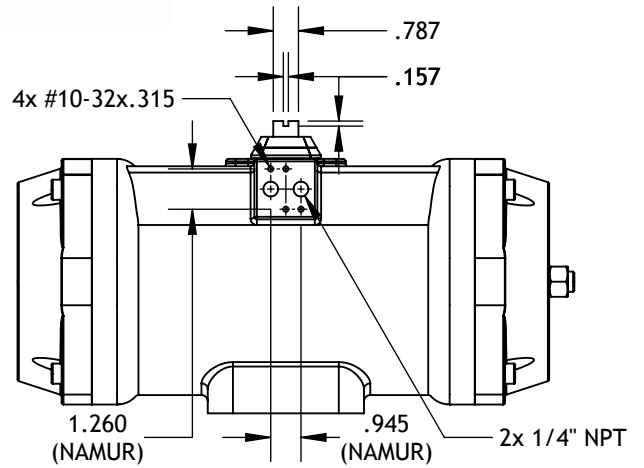
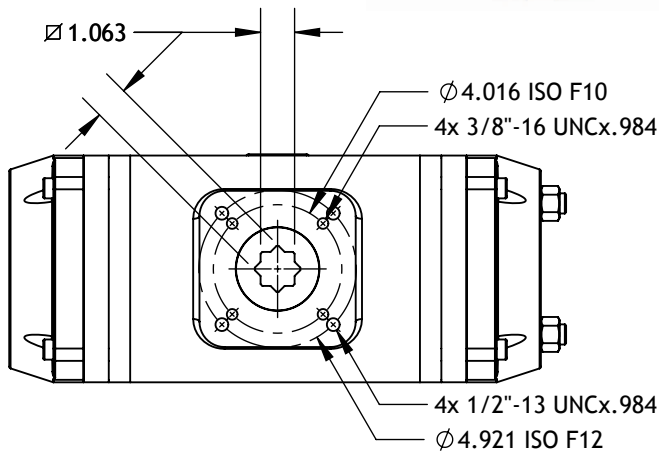

	Double Acting	Spring Return
Air Consumption (Full Cycle)	565.5 in <sup>3</sup>	256.3 in <sup>3</sup>
Weight	71.5 lbs	82.1 lbs (7+5 Springs)

**Max-Air** Technology Inc.

751 Hoff Road - O'Fallon, Missouri 63366 U.S.A.  
www.max-airtechnology.com info@max-airtechnology.com