

**SS46**  
TECHNICAL DATA

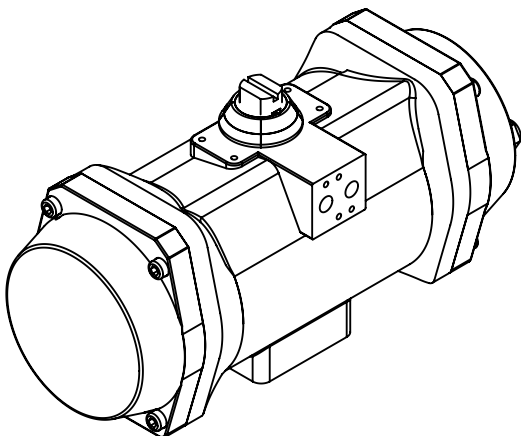

DIMENSIONS TO  
ISO 5211 - DIN 3337  
AND NAMUR VDI/VDE 3845

DIMENSIONS IN INCHES

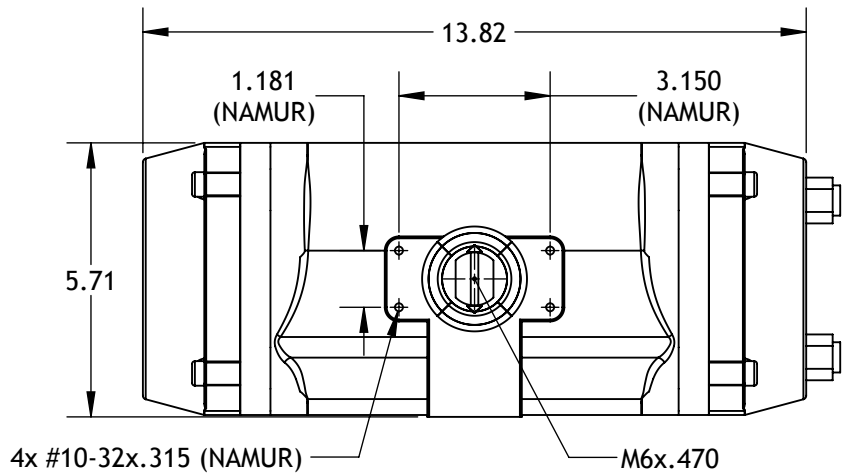
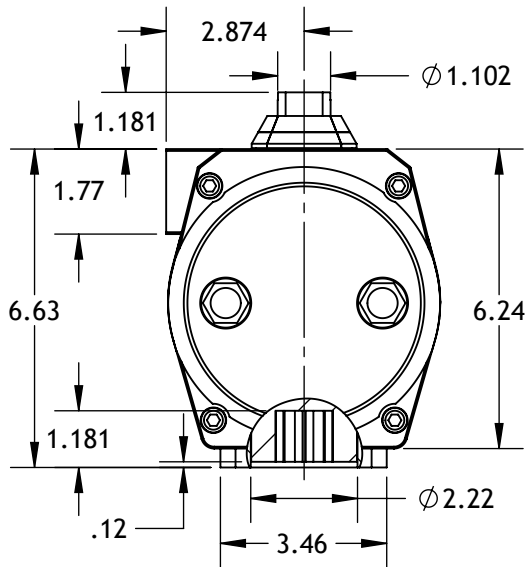
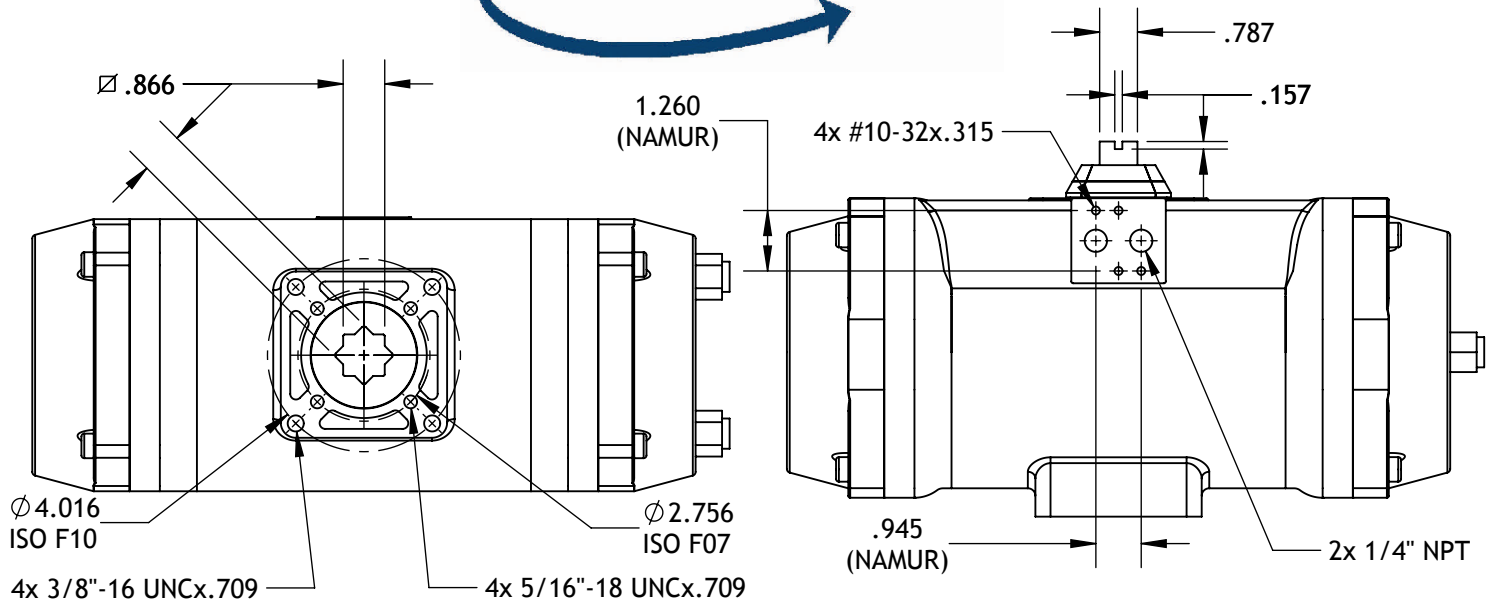

	Double Acting	Spring Return
Air Consumption (Full Cycle)	275.0 in <sup>3</sup>	115.6 in <sup>3</sup>
Weight	36.6 lbs	42.3 lbs (7+5 Springs)

**Max-Air** Technology Inc.

751 Hoff Road - O'Fallon, Missouri 63366 U.S.A.  
www.max-airtechnology.com info@max-airtechnology.com